

VIKING

TECHNICAL Practice

TELECOM SOLUTIONS FOR THE 21ST CENTURY

PA-2A
Paging Amplifier
Loud Ringer

April 6, 2010

Add Paging and Multiple Line Loud Ringing to Any Phone System

The **PA-2A** provides loud ringing and paging to electronic key systems, 1A2 Key systems, PABX's as well as No-KSU phones and multiline phones.

Paging is accomplished by connecting the **PA-2A** to a paging port or unused telephone line input (trunk port) of nearly any phone system.

The **PA-2A** will also generate adjustable loud ringing from up to 6 analog lines or from a dry contact closure. Either a loud electronic warble, or one of three other soft chime sounds may be selected. An external "night transfer" switch can be added to turn loud ringing on or off in night bell applications.

The **PA-2A** is easy to install and eliminates the installation of multiple bells, relays and paging cards. The unit comes complete with a power supply, amplifier and (1) paging horn.



Features

- Two watts of paging power
- **All lines are optically coupled for compatibility with fax switches and analog PABX/KSU stations**
- Can provide background music from an external source (trunk mode only)
- Paging from an unused trunk port or paging port
- **Choose one of four ringing sounds:**
 - Electronic warble (traditional loud ringer)
 - Double gong (two identical "gong" tones)
 - Quadruple chime (four descending chime tones)
 - Door chime (ding-dong)
- Provides loud ringing or night bell, from 1-6 lines for warehouses, yards, etc.
- Output for controlling a 12 volt relay from 1-6 ringing lines
- **Page alert tone (trunk mode only)**
- **600 ohm output for sourcing high powered amplifiers**

Applications

- Amplified loud paging
- Night bell
- Loud ringing

Phone... 715.386.8861

info@vikingelectronics.com

<http://www.vikingelectronics.com>

Specifications

Power: 120V AC/13.8V AC 1.25A, UL listed adapter provided
Dimensions: 133mm x 89mm x 44mm (5.25" x 3.5" x 1.75")
Shipping Weight: 1.36 kg (3 lbs)
Environmental: 0°C to 32°C (32°F to 90°F) with 5% to 95% non-condensing humidity
Paging Output: 2 watts - powers up to (3) 8 ohm or (16) 45 ohm speakers
Sound Pressure: 110 dB @ 1 meter (loud electronic warble)
Speakers: (1) 25AE 8 ohm paging horn included, (3) maximum
Maximum Speaker Run: 91m (300 ft) maximum 18 AWG
Talk Battery: 24V DC
Connections: (2) RJ25 jacks, (1) 10 position screw terminal block

IF YOU HAVE A PROBLEM WITH A VIKING PRODUCT, PLEASE CONTACT: VIKING TECHNICAL SUPPORT AT (715) 386-8666

Our Technical Support Department is available for assistance Monday 8am - 4pm and Tuesday through Thursday 8am - 5pm central time. So that we can give you better service, before you call please:

1. Know the model number, the serial number and what software version you have (see serial label).
2. Have your Technical Practice in front of you.
3. It is best if you are on site.

RETURNING PRODUCT FOR REPAIR

The following procedure is for equipment that needs repair:

1. Customer must contact Viking's Technical Support Department at 715-386-8666 to obtain a Return Authorization (RA) number. The customer MUST have a complete description of the problem, with all pertinent information regarding the defect, such as options set, conditions, symptoms, methods to duplicate problem, frequency of failure, etc.
2. Packing: Return equipment in original box or in proper packing so that damage will not occur while in transit. Static sensitive equipment such as a circuit board should be in an anti-static bag, sandwiched between foam and individually boxed. All equipment should be wrapped to avoid packing material lodging in or sticking to the equipment. Include ALL parts of the equipment. C.O.D. or freight collect shipments cannot be accepted. Ship cartons prepaid to:
Viking Electronics, 1531 Industrial Street, Hudson, WI 54016
3. Return shipping address: Be sure to include your return shipping address inside the box. We cannot ship to a PO Box.
4. RA number on carton: In large printing, write the R.A. number on the outside of each carton being returned.

RETURNING PRODUCT FOR EXCHANGE

The following procedure is for equipment that has failed out-of-box (within 10 days of purchase):

1. Customer must contact Viking's Technical Support at 715-386-8666 to determine possible causes for the problem. The customer MUST be able to step through recommended tests for diagnosis.
2. If the Technical Support Product Specialist determines that the equipment is defective based on the customer's input and troubleshooting, a Return Authorization (R.A.) number will be issued. This number is valid for fourteen (14) calendar days from the date of issue.
3. After obtaining the R.A. number, return the approved equipment to your distributor, referencing the R.A. number. Your distributor will then replace the product over the counter at no charge. The distributor will then return the product to Viking using the same R.A. number.
4. **The distributor will NOT exchange this product without first obtaining the R.A. number from you. If you haven't followed the steps listed in 1, 2 and 3, be aware that you will have to pay a restocking charge.**

WARRANTY

Viking warrants its products to be free from defects in the workmanship or materials, under normal use and service, for a period of one year from the date of purchase from any authorized Viking distributor or 18 months from the date manufactured, whichever ever is greater. If at any time during the warranty period, the product is deemed defective or malfunctions, return the product to Viking Electronics, Inc., 1531 Industrial Street, Hudson, WI, 54016. Customer must contact Viking's Technical Support Department at 715-386-8666 to obtain a Return Authorization (R.A.) number.

This warranty does not cover any damage to the product due to lightning, over voltage, under voltage, accident, misuse, abuse, negligence or any damage caused by use of the product by the purchaser or others.

Viking's sole responsibility shall be to repair or replace (at Viking's option) the material within the terms stated above. VIKING SHALL NOT BE LIABLE FOR ANY LOSS OR DAMAGE OF ANY KIND INCLUDING INCIDENTAL OR CONSEQUENTIAL DAMAGES RESULTING DIRECTLY OR INDIRECTLY FROM ANY BREACH OF ANY WARRANTY EXPRESSED OR IMPLIED, OR FOR ANY OTHER FAILURE OF THIS PRODUCT. Some states do not allow the exclusion or limitation of incidental or consequential damages, so this limitation may not apply to you.

THIS WARRANTY IS IN LIEU OF ALL OTHER WARRANTIES, EXPRESSED OR IMPLIED, INCLUDING THE WARRANTIES OF MERCHANTABILITY AND FITNESS FOR A PARTICULAR PURPOSE, WHICH ARE HEREBY EXCLUDED BEYOND THE ONE YEAR DURATION OF THIS WARRANTY. Some states do not allow limitation on how long an implied warranty lasts, so the above limitation may not apply to you.

FCC REQUIREMENTS

This equipment complies with Part 68 of the FCC rules. Located on the equipment is a label that contains, among other information, the FCC registration number and ringer equivalence number (REN). If requested, this information must be provided to the telephone company.

The REN is used to determine the quantity of devices which may be connected to the telephone line. Excessive REN's on the telephone line may result in the devices not ringing in response to an incoming call. In most, but not all areas, the sum of the REN's should not exceed five (5.0). To be certain of the number of devices that may be connected to the line, as determined by the total REN's, contact the telephone company to determine the maximum REN for the calling area.

This equipment cannot be used on the telephone company-provided coin service. Connection to Party Line Service is subject to State Tariffs.

If this equipment causes harm to the telephone network, the telephone company will notify you in advance that temporary discontinuance of service may be required. If advance notice isn't practical, the telephone company will notify the customer as soon as possible. Also, you will be advised of your right to file a complaint with the FCC if you believe it is necessary.

The telephone company may make changes in its facilities, equipment, operations, or procedures that could affect the operation of the equipment. If this happens, the telephone company will provide advance notice in order for you to make the necessary modifications in order to maintain uninterrupted service.

If trouble is experienced with this equipment, please contact: **Viking Electronics, Inc., 1531 Industrial Street, Hudson, WI 54016 (715) 386-8666**

If the trouble is causing harm to the telephone network, the telephone company may request you to remove the equipment from the network until the problem is resolved.

The PA-2A uses the USOC jacks RJ11C, RJ14C, and RJ25C.

It is recommended that the customer install an AC surge arrester in the AC outlet to which this device is connected. This is to avoid damaging the equipment caused by local lightning strikes and other electrical surges.

This equipment is Hearing-Aid Compatible (HAC).

The telephone Consumer Protection Act of 1991 makes it unlawful for any person to use a computer or other electronic device, including fax machines, to send any message unless such message clearly contains in a margin at the top or bottom of each transmitted page or on the first page of the transmission, the date and time it is sent and an identification of the business or other entity, or other individual sending the message and the telephone number of the sending machine or such business, other entity, or individual. (The telephone number provided may not be a 900 number or any other number for which charges exceed local or long-distance transmission charges.)

PART 15 LIMITATIONS

This equipment has been tested and found to comply with the limits for a Class A digital device, pursuant to Part 15 of the FCC Rules. These limits are designed to provide reasonable protection against harmful interference when the equipment is operated in a commercial environment. This equipment generates, uses, and can radiate radio frequency energy and, if not installed and used in accordance with the instruction manual, may cause harmful interference to radio communications. Operation of this equipment in a residential area is likely to cause harmful interference in which case the user will be required to correct the interference at his own expense.

Installation and Programming

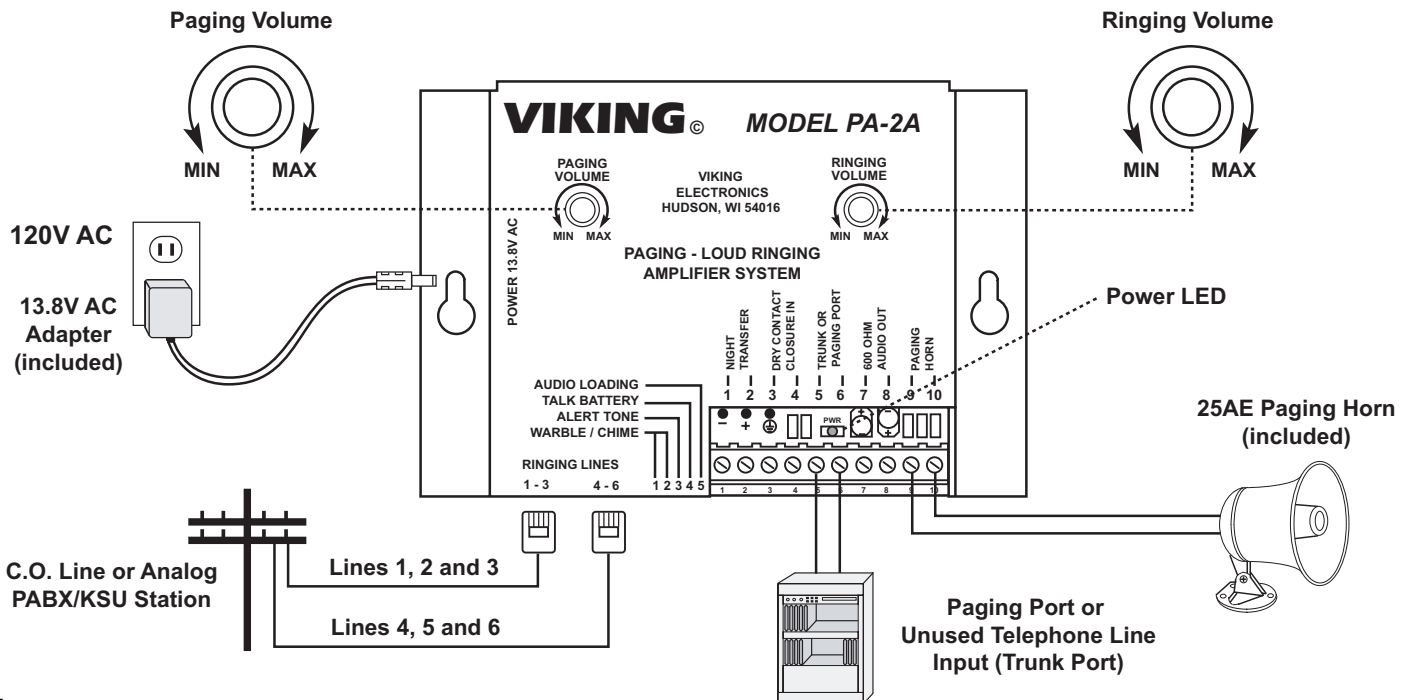

A. Amplified Loud Paging

1. Paging Port

Step 1.	Move the TALK BATTERY switch to the OFF position (DIP switch 4).
Step 2.	Connect pins 5 and 6 to the paging port output.

Important: Page Alert Tone or background music can **NOT** be added when interfacing the **PA-2A** to a Paging Port.

Note: For information on speakers to use, ambient noise levels and speaker wiring, see **DOD# 498**.

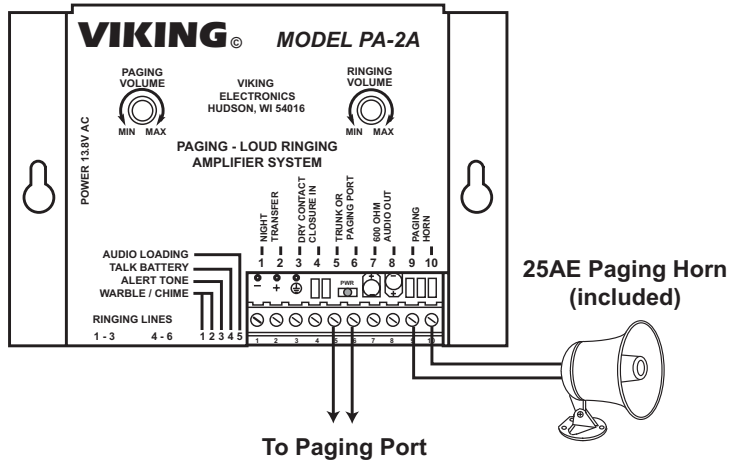

2. Trunk/Line Port

Step 1.	Move the TALK BATTERY switch to the ON position (DIP switch 4).
Step 2.	Move the AUDIO LOADING switch to the OFF position (DIP switch 5).
Step 3.	Connect pins 5 and 6 to an unused telephone line input (trunk port).
Step 4.	Background music may be added as shown, the music level will be greatly reduced during a page.

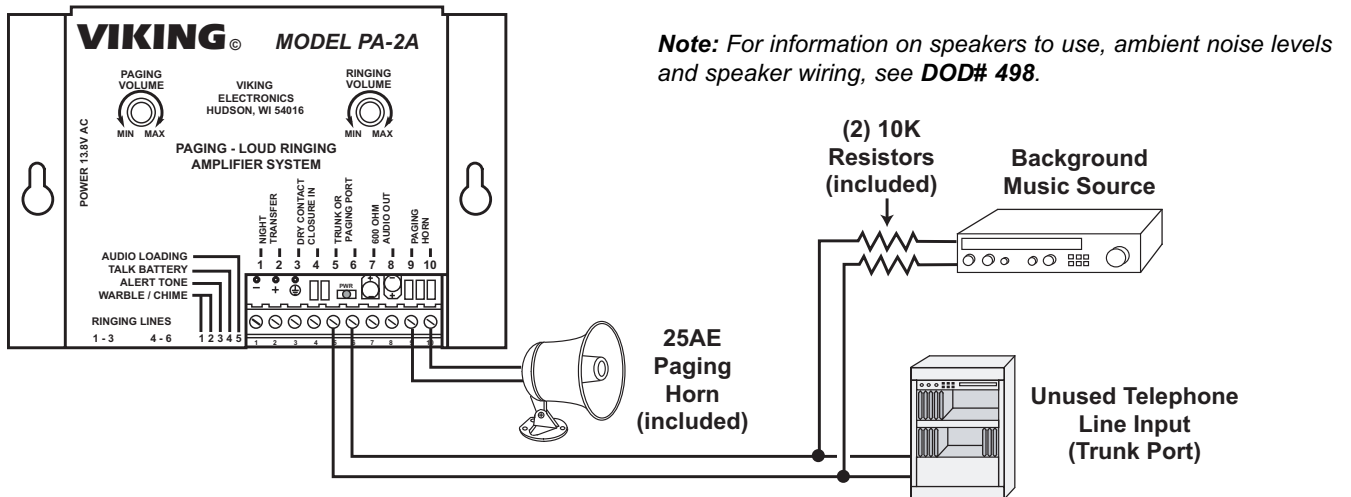

B. Loud Ringing/Night Bell

1. Ringing Analog Lines

Step 1.	Connect lines 1 (R/G), 2 (Y/BK) and 3 (BL/W) to RINGING LINES 1-3 .
Step 2.	Connect lines 4 (R/G), 5 (Y/BK) and 6 (BL/W) to RINGING LINES 4-6 .

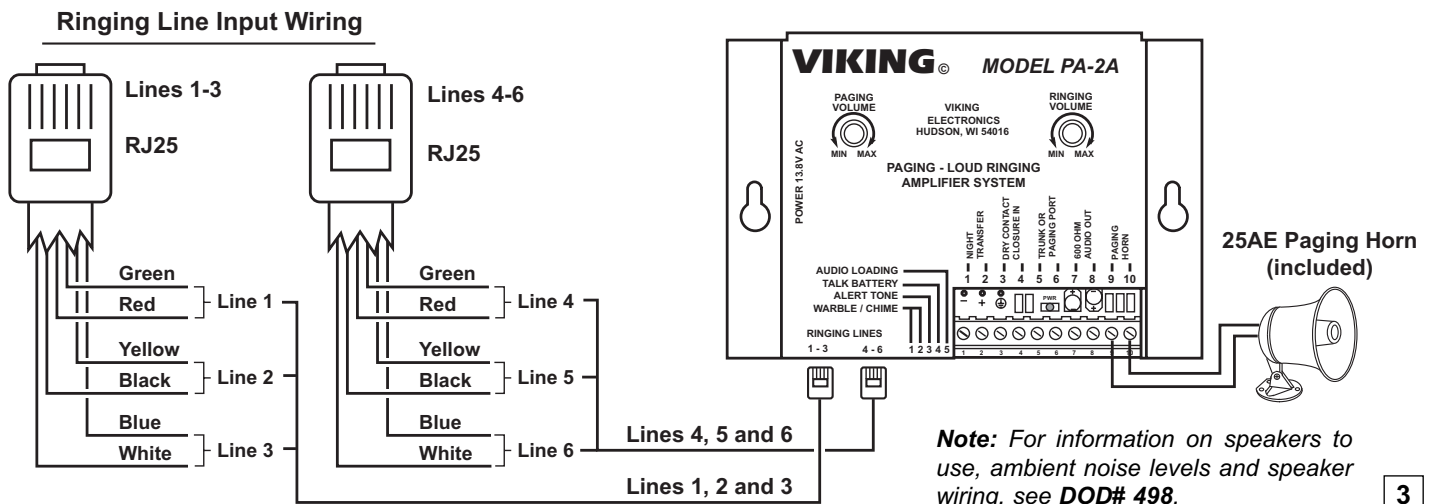

2. Dry Contact (Common Audible) Closure (contacts not included)

Step 1.	Connect the dry contact closure to pins 3 and 4.
Step 2.	A dry contact closure will initiate loud ringing.

Note: For information on speakers to use, ambient noise levels and speaker wiring, see **DOD# 498**.

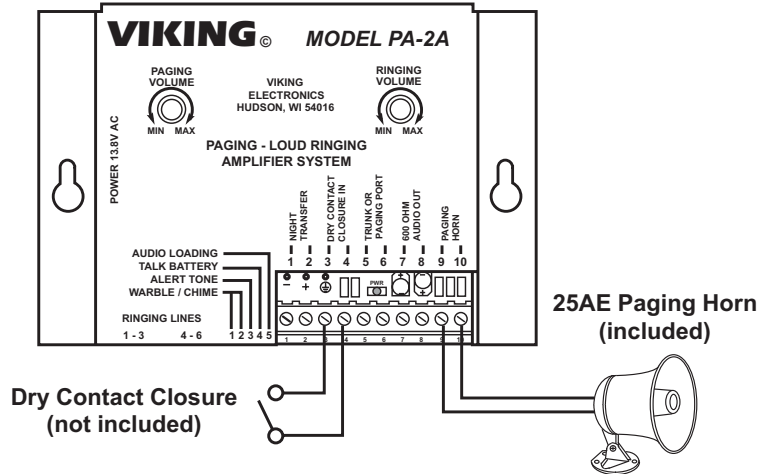

3. Night Transfer (Loud Ringing) Switch (switch not included)

A Night Transfer Switch may be used to enable or disable loud ringing.

a. Ringing Analog Lines

Connect the night transfer switch to terminal pins 1 and 2. When the switch is on (closed), loud ringing is disabled. When the switch is off (open), loud ringing is enabled.

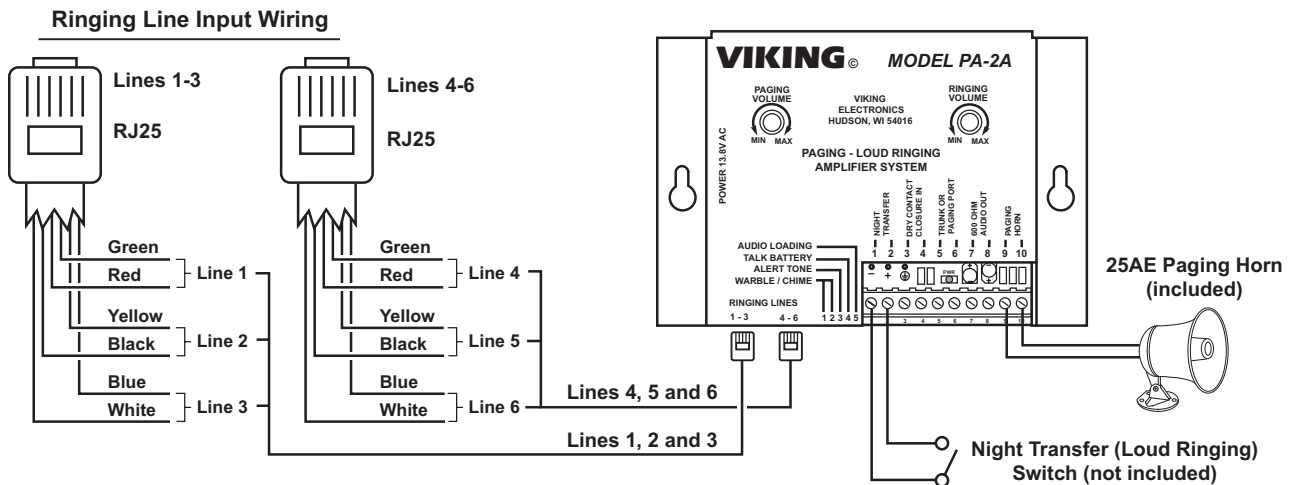

Note: For information on speakers to use, ambient noise levels and speaker wiring, see **DOD# 498**.

b. Dry Contact Closure with Night Transfer (Loud Ringing) Switch

Interface the night transfer switch in series with the contact closure. When the switch is on (closed), loud ringing is enabled. When the switch is off (open), loud ringing is disabled.

Note: For information on speakers to use, ambient noise levels and speaker wiring, see **DOD# 498**.

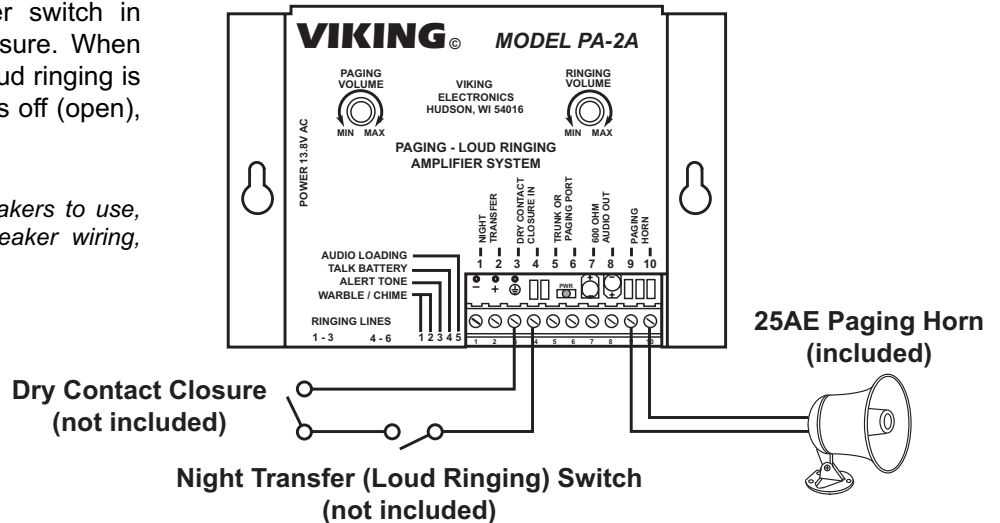

C. Contact Closure from Up to 6 Ringing Lines

When a 12V DC relay coil (Radio Shack part: # 275-248, not included) is connected as shown in the diagram below, the relay is activated for the duration of each ring on 1-6 C.O. lines or analog PABX/KSU stations.

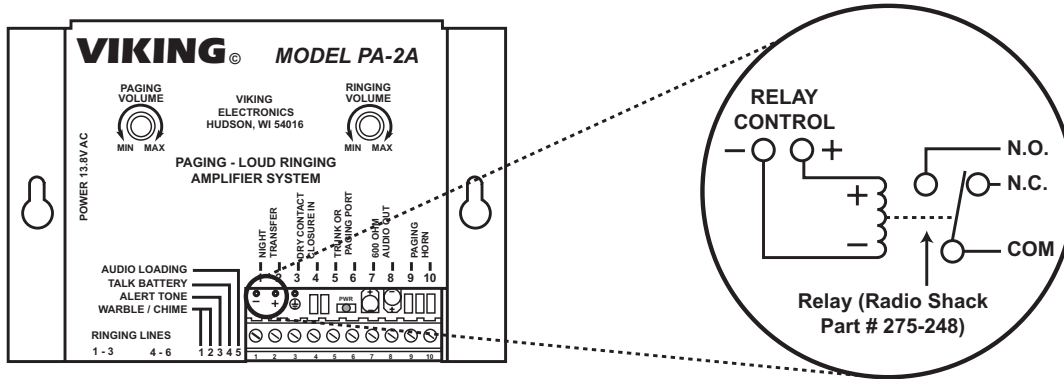

D. Long Runs Between Amplifier and Speakers

Very long runs between the PA-2A and the speakers might require 70V transformers (Parts Express 1-800-338-0531, part # 300-040 or equivalent).

Note: For additional information on how to minimize loss of audio in long speaker runs, see **DOD# 856**.

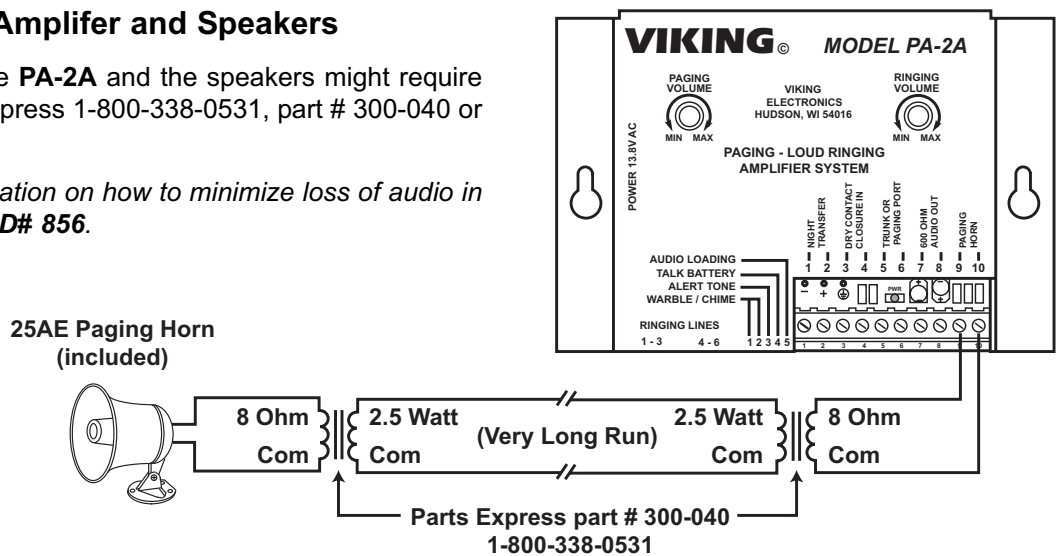

E. Connecting Multiple PA-2A's

When more than 6 ringing lines are to be monitored or additional amplifiers need to be added, install as shown below, using the 600 OHM AUDIO OUTPUT connections.

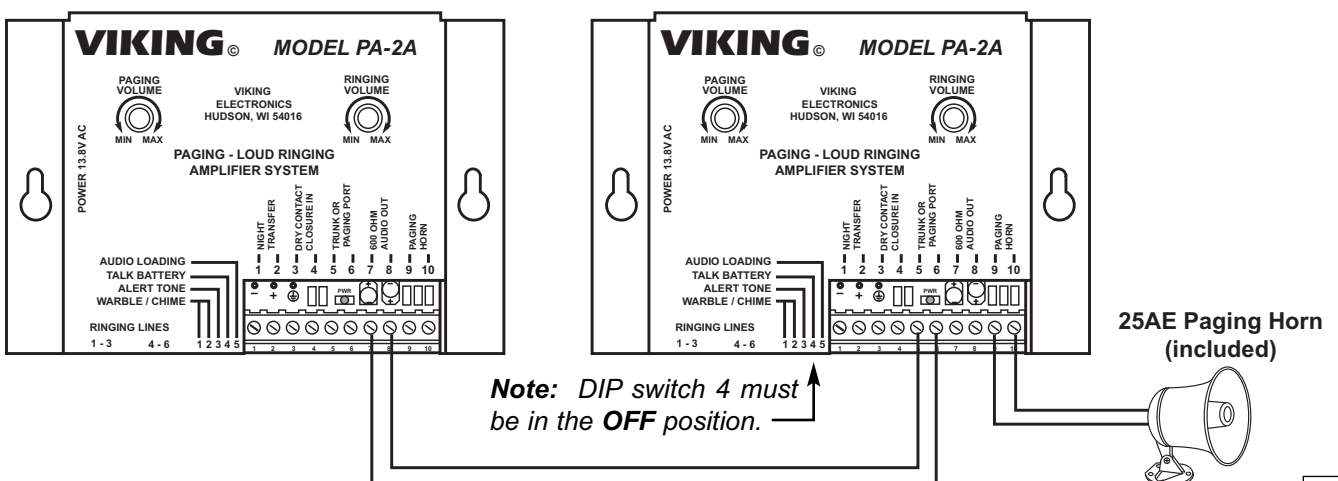

F. Adding Additional Paging Power

An external amplifier can be added to increase the paging and loud ringing power. Simply connect the **600 OHM AUDIO OUTPUT** screw terminals to the line level input of any high powered paging amplifier, such as the Viking PA-30, or any existing paging system.

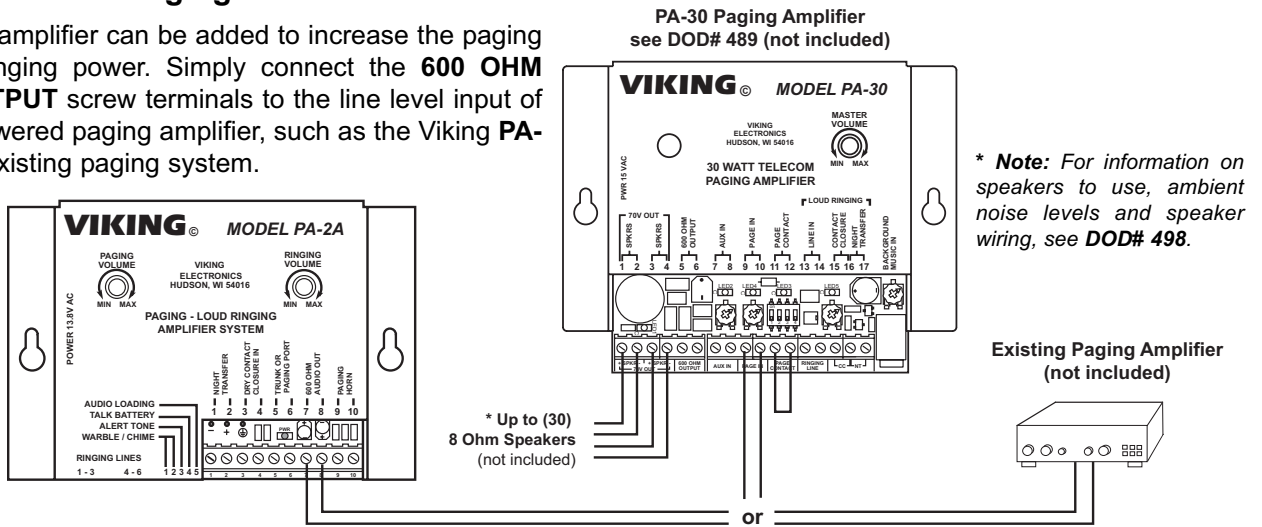

G. Add Paging to Homes and Small Business with Single Line Phones

The **C-1000B** can be added to allow **PA-2A** paging from the existing single line phones. If need be, a doorbox or a second paging amplifier may also be added to the **C-1000B** Doorbox 2 Terminals. For more information on the **C-1000B**, see **DOD# 168**.

C-1000B Door Entry/Paging Controller (not included)

Step 1.	Program the C-1000B to be in the Paging Mode *4.
Step 2.	Set the C-1000B Talk Battery switch OFF .
Step 3.	Connect the PA-2A Trunk Port (pins 5 & 6) to the C-1000B Door Box 1 terminals.
Step 4.	Move the PA-2A Talk Battery switch ON (DIP switch 4).
Step 5.	To page, come off hook on the phone and dial #1.

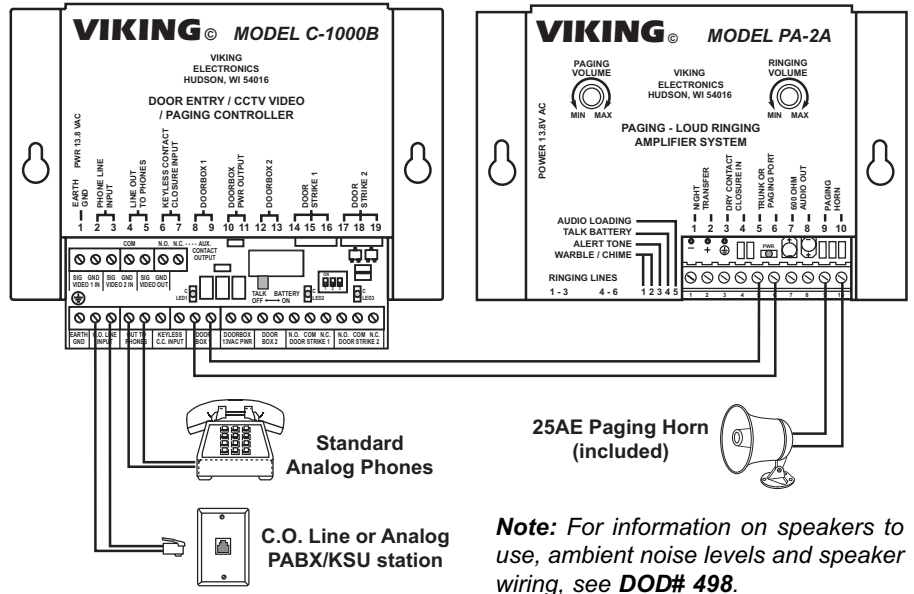

H. DIP Switch Programming

Switch 1	Switch 2	Sound Output Description
OFF	OFF	Electronic Warble
OFF	ON	Double Gong
ON	OFF	Quadruple Chime
ON	ON	Door Chime

Switch	Position	Description
3	OFF	Alert tone OFF (factory default)
3	ON	Alert tone ON
4	OFF	Talk battery OFF (factory default)
4	ON	Talk battery ON
5	OFF	Audio load 10K (for applications using background music)
5	ON	Audio load 600 ohms (factory default)

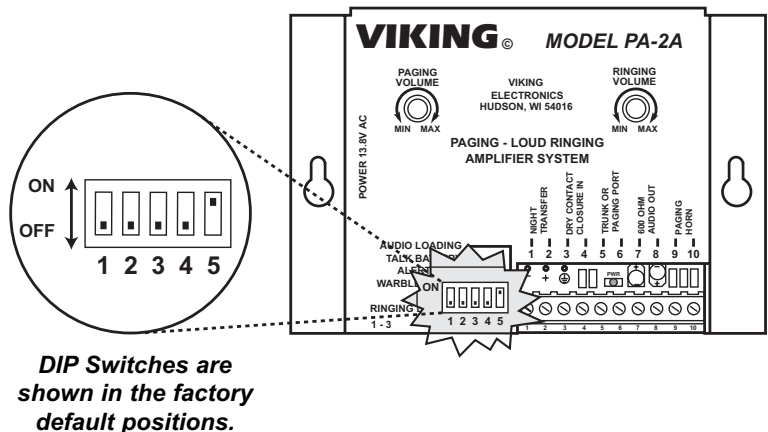

Sound Output Specifications

All tones require a minimum of 180ms of ringing voltage (or contact closure) to trigger. Once triggered, the electronic warble will run continuously until ringing stops (or contacts open). All other tones (double gong, quadruple chime, doorbell) will run through their full sequence once and will not cycle again until the ringing stops (or contact opens) for at least 50ms and a second ring signal (or contact closure) triggers them again.

A. Electronic Warble (Traditional Loud Ringer)

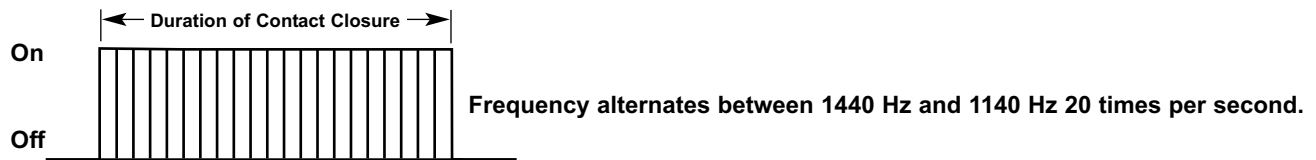

B. Double Gong (Two "Gong" Tones)

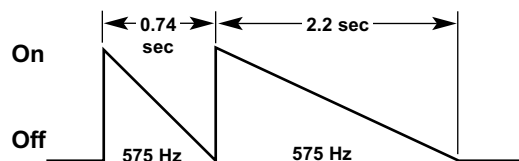

C. Quadruple Chime (Four Descending Chime Tones)

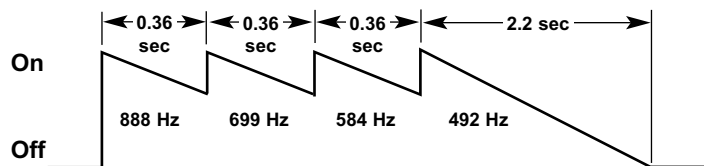

D. Door Chime (Ding-Dong)

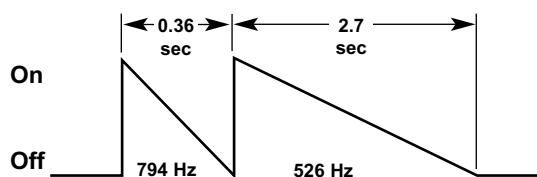

Operation

When interfacing the **PA-2A** to a paging port, the **TALK BATTERY** switch (DIP switch 4) must be **OFF**. The **PA-2A** will amplify all signals sent from the paging port. The page alert tone (DIP switch 3) is not an available option.

When interfacing with an unused telephone line input (trunk port), the **TALK BATTERY** switch (DIP switch 4) must be **ON** and the **PA-2A** must be connected to an unused trunk port. Simply access that trunk port and talk into the handset to page. A page alert tone may be enabled or disabled with DIP switch 3. When the page alert tone is enabled, paging will interrupt and hold off loud ringing for the duration of the page.

In both instances, the **PA-2A** can monitor 1 - 6 C.O. lines, 1 - 6 analog PABX/KSU stations or a dry contact closure for loud ringing. The **PA-2A** will produce the selected ringing tone when ring voltage is detected on these line inputs or a contact is closed on pins 3 and 4. Select the electronic warble tone (traditional loud ringing) for noisy areas. The softer chime tones work well in less noisy environments.

Related Products



The **25AE** and **30AE** paging speakers provide additional economical paging coverage to existing Viking paging units (**PA-2A**, **CPA-7B**, **HF-3W**, **M2W**) or to any system with an 8 ohm output.

In outdoor, factory or warehouse environments, **25AE** paging horns are the best method of producing understandable sound. In these environments the directional design allows the installer to focus the sound cone down aisles and toward work areas. In office and restaurant environments, it is best to distribute sound more evenly.

Ceiling mounted **30AE** speakers in close proximity offer the best distribution and are cost effective.

The **25AE** Paging Horn features: adjustable base for easy mounting and directional adjustment, compact design for out of the way mounting, and is designed to work with all of Viking's paging products. The **30AE** Ceiling Speaker features: attractive white grill for flush mounting in office ceiling, mounting hardware included, large permanent magnet, excellent frequency response, and is designed to work with all of Viking's paging products.

For more information on the **25AE** and **30AE**, see **DOD# 498**.

The **CPA-7B** is a cost effective, multi- purpose, telecom paging system. The unit features a low noise, high fidelity amplifier, providing 6 watts of power for a variety of telecom paging applications. It can also provide background music and night bell/common audible. In addition, multiple units may be daisy-chained for larger paging applications.

The **CPA-7B** allows paging from any one of the following: an unused trunk input, a page port, a C.O. line, Centrex line or analog PABX/KSU station port. For loud ringing, the **CPA-7B** generates an adjustable loud warble from a dry contact closure, a ringing C.O. line or a ringing analog PABX/KSU station port.

For more information on the **CPA-7B**, see **DOD# 455**.



Even the best designed paging systems can experience feedback. Now you can eliminate annoying feedback over your paging speakers with Viking's model **FBI-1A** digital anti-feedback paging interface. The **FBI-1A** utilizes state of the art digital recording technology to record the "live" page from a phone system's paging port output or unused trunk port. The **FBI-1A** then immediately plays back the recorded page once or twice (selectable) over the paging system.

Pages of up to 16 seconds (expandable to 60 seconds) can be stored and the **FBI-1A** automatically adjusts to the page length for faster processing. In addition, the **FBI-1A** can be programmed to provide pre-page and post-page alert tones.

For more information on the **FBI-1A**, see **DOD# 465**.

The **PA-30** can directly drive up to thirty (30) 8 ohm paging speakers or fifty (50) 70 volt paging speakers. The **PA-30** provides loud ringing and paging to electronic key systems, 1A2 Key systems, PABX's as well as No-KSU phones and multi-line phones.

Paging is accomplished by connecting the **PA-30** to a paging port or unused telephone line input (trunk port) of nearly any phone system. The **PA-30** will also generate adjustable loud ringing from a ringing analog line or from a dry contact closure. Either a loud electronic warble, or one of three other soft chime sounds may be selected. An external "night transfer" switch can be added to turn loud ringing on or off in night bell applications.

For more information on the **PA-30**, see **DOD# 489**.



Product Support Line...715.386.8666

Fax Back Line...715.386.4345

Due to the dynamic nature of the product design, the information contained in this document is subject to change without notice. Viking Electronics, and its affiliates and/or subsidiaries assume no responsibility for errors and omissions contained in this information. Revisions of this document or new editions of it may be issued to incorporate such changes.